

### Pull Location

(Front View)

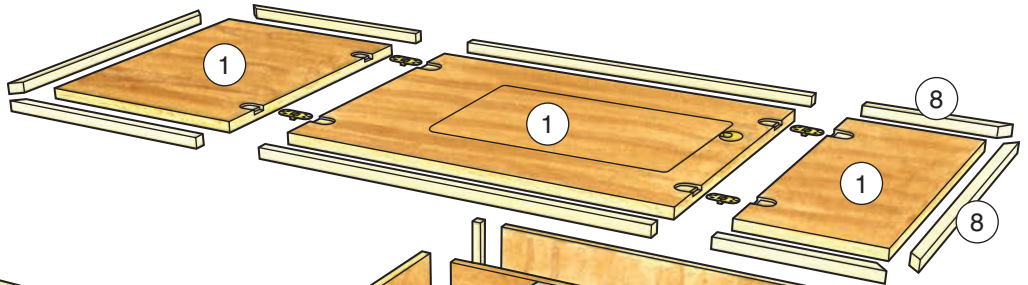
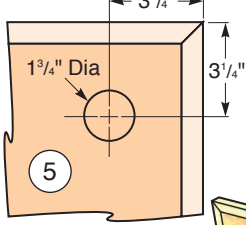

### Lift Support Locations

(Front View)

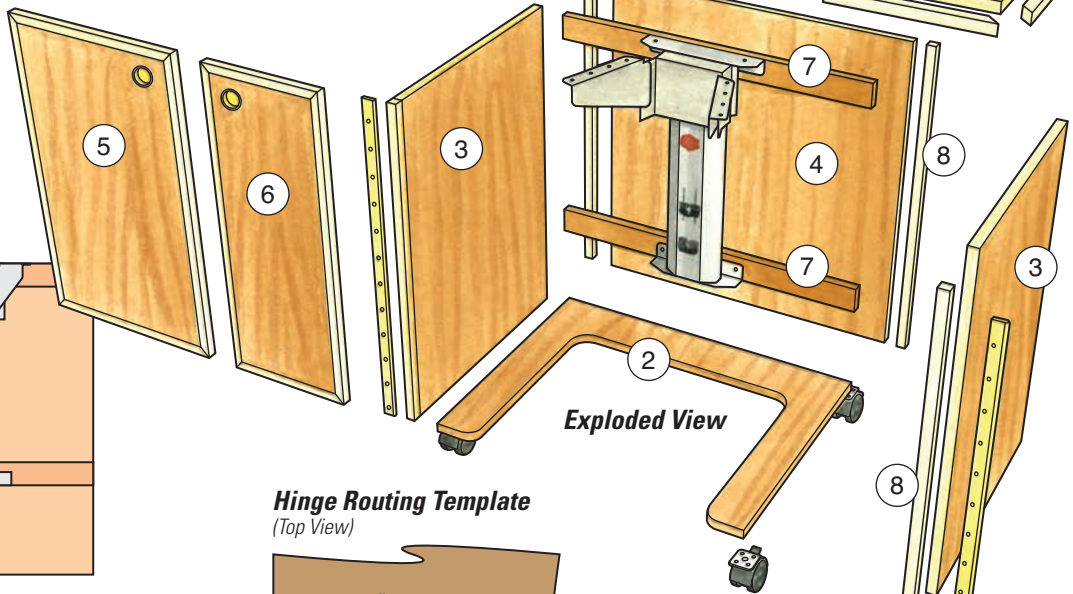
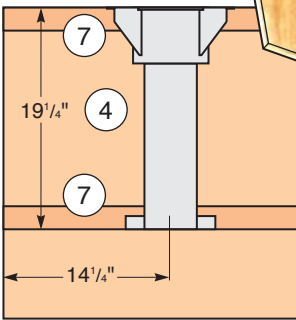

Exploded View

### Hinge Routing Template

(Top View)

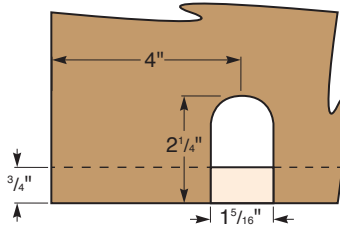

### Bottom

(Top View)

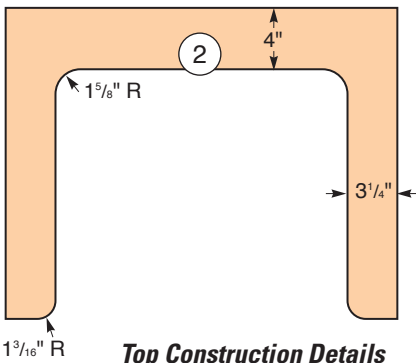

The sewing machine platform is cut from the Top (Piece 1). The location and size of the Platform shown below will accommodate most sewing machines. If your machine is extra large, you may need to enlarge the platform. Check your machine dimensions in advance.

### Top Construction Details

(Top View)

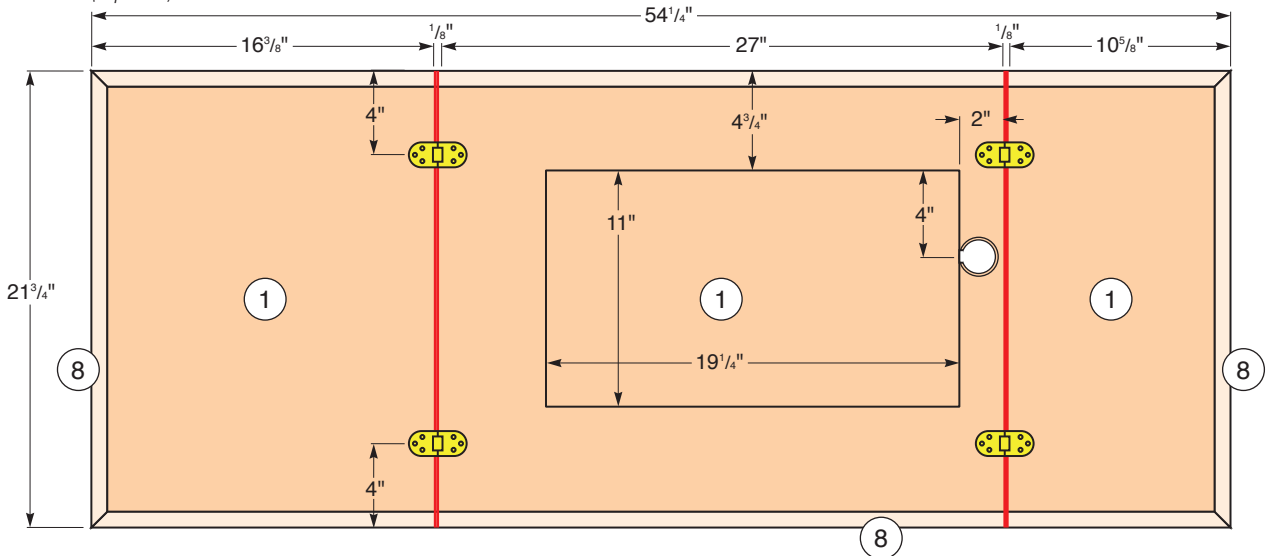

### MATERIAL LIST

	T x W x L
1 Top Panel (1)	3/4" x 20 1/4" x 52 3/4"*
2 Bottom (1)	3/4" x 25 1/2" x 20 1/4"
3 Side Panels (2)	3/4" x 19 1/4" x 27"
4 Back Panel (1)	3/4" x 25 1/2" x 27"
5 Left Door Panel (1)	3/4" x 14 7/8" x 25 1/2"
6 Right Door Panel (1)	3/4" x 9 7/8" x 25 1/2"
7 Lift Supports (2)	3/4" x 2" x 25 1/2"
8 Edging (1)	3/4" x 3/4" x 454"

\* This panel will be cut down to size to form the leaves