

Front Leg

(Top, Inside and Back Views)

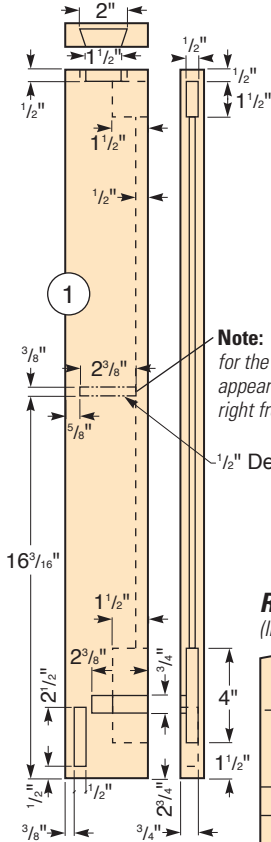

Note: This mortise for the drawer divider appears only on the right front leg.

Rear Leg

(Inside View)

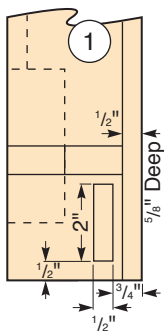

Note: The front legs and back legs are not exact duplicates. The two key changes are a 5/8"-wide groove plowed 1/2"-deep that runs along the back edge of the back legs, plus different sizes and locations of the mortises for the rear rail.

Plywood Bottom

(Top View)

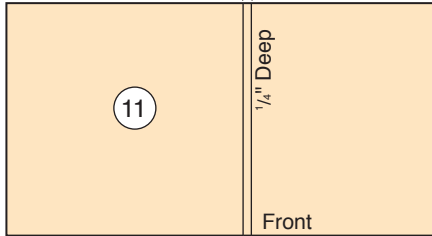

Edging for Plywood Vertical Divider

(Inside View)

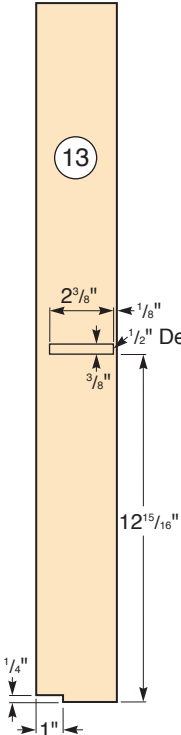

Upper and Lower Side Rails

(End and Inside Views)

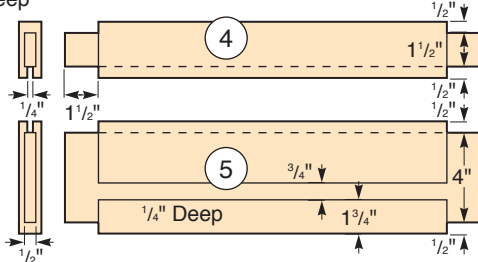

Plywood Vertical Divider

(Side View)



Exploded View

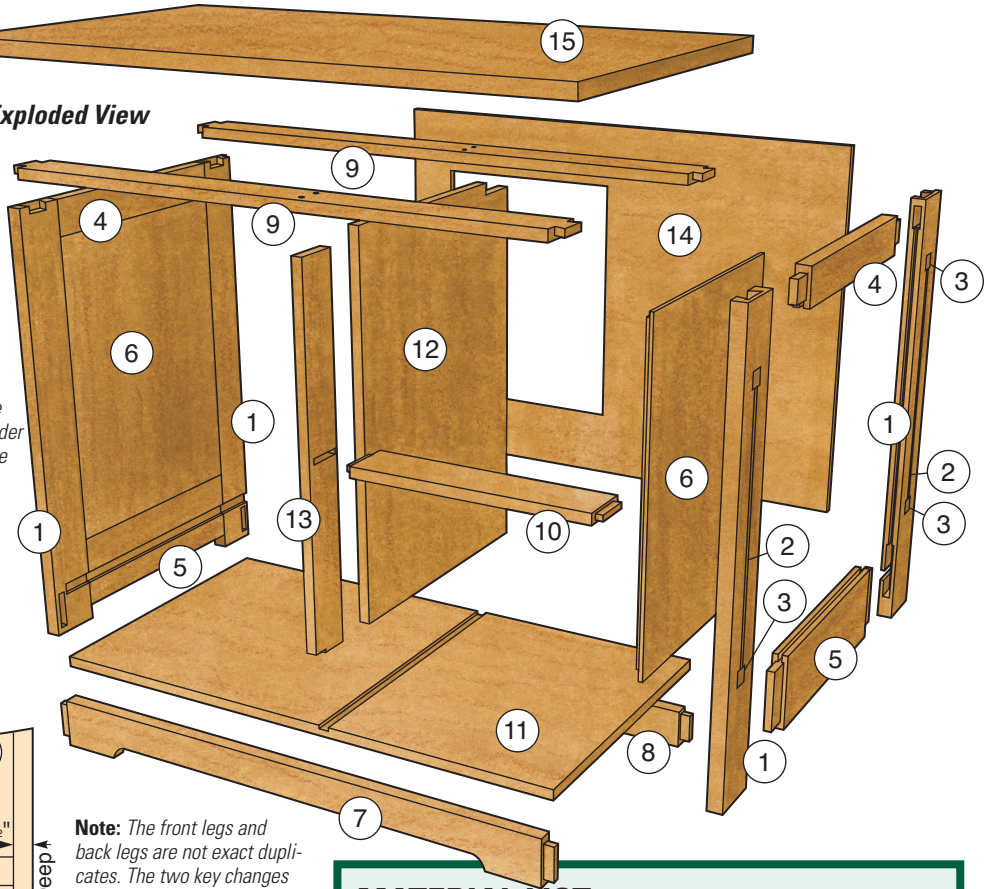

MATERIAL LIST

Lower Cabinet	T x W x L
1 Legs (4)	1" x 3 1/2" x 30"
2 Inlay Material, Walnut (4)	1/4" x 3/8" x 16 1/2"
3 Inlay Material, Walnut (8)	3/8" x 1" x 1"
4 Side Rails, Upper (2)	1" x 2 1/2" x 18 1/2"
5 Side Rails, Lower (2)	1" x 5" x 18 1/2"
6 Side Panels (2)	5/8" x 16 1/2" x 22 1/2"
7 Long Lower Rail, Front (1)	1" x 3 1/2" x 39 1/2"
8 Long Lower Rail, Rear (1)	1" x 2 3/4" x 39 1/2"
9 Dovetailed Rails (2)	3/4" x 3" x 39 1/2"
10 Drawer Divider (1)	3/4" x 3 3/8" x 17 1/4"
11 Plywood Bottom (1)	3/4" x 20 7/8" x 38 1/2"
12 Plywood Vertical Divider (1)	3/4" x 18 7/8" x 26 3/4"
13 Edging for Plywood Vertical Divider (1)	3/4" x 3" x 26"
14 Plywood Back Panel (1)	1/2" x 39 1/4" x 30"
15 Top Panel (1)	1" x 24" x 43"

Long Lower Rail, Front

(End and Front Views)

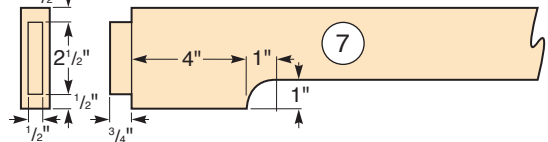

Long Lower Rail, Rear

(End and Front Views)



Door Stiles
(Front and Inside Views)

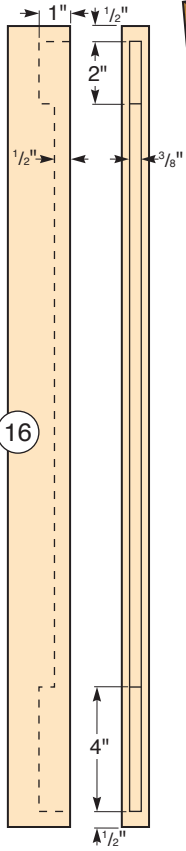

Door Rail Top and Bottom (Front and End Views)

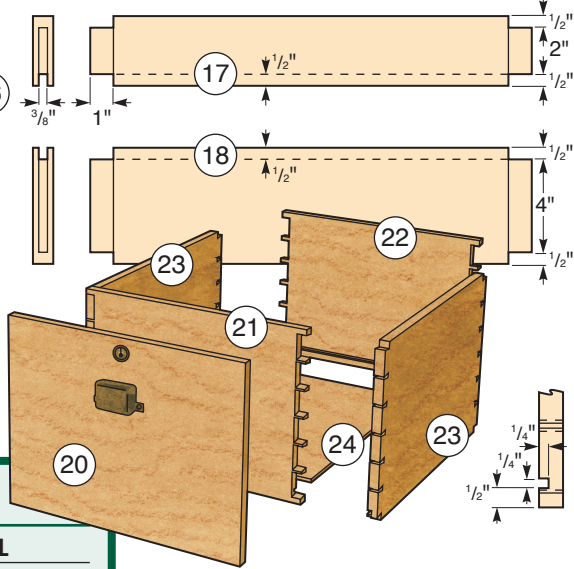

Drawer Side
(End and Side Views)

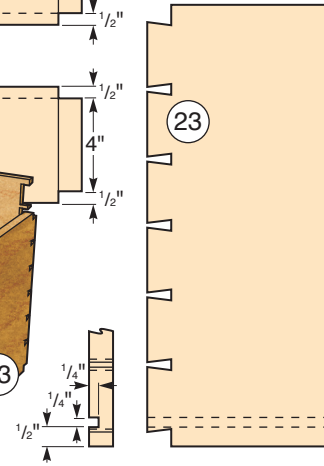

MATERIAL LIST

Doors and Drawers	T x W x L
16 Door Stiles (2)	7/8" x 2" x 25 3/4"
17 Door Rail, Top (1)	7/8" x 3" x 19"
18 Door Rail, Bottom (1)	7/8" x 5" x 19"
19 Door Panel (1)	5/8" x 18" x 18 3/4"
20 Drawer False Fronts (2)	5/8" x 12 1/2" x 16 1/4"
21 Drawer Fronts (2)	5/8" x 11 1/2" x 15 7/8"
22 Drawer Backs (2)	5/8" x 11 1/2" x 15 7/8"
23 Drawer Sides (4)	5/8" x 11 1/2" x 18"
24 Drawer Bottoms (2)	1/4" x 15 3/32" x 17 1/4"

Routing Template Layout
(Top View)

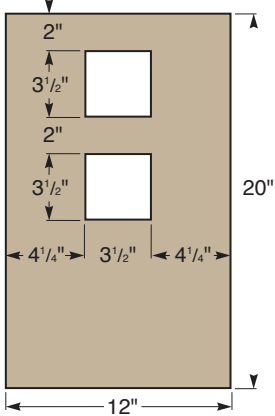

Inlay
(Front View)

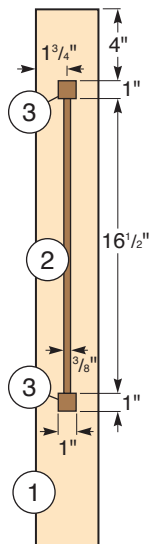

Side
(Inside View)

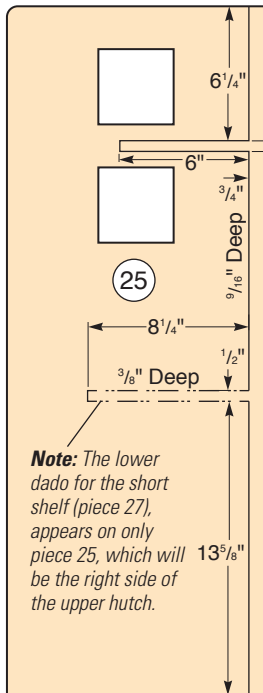

Note: The lower dado for the short shelf (piece 27), appears on only piece 25, which will be the right side of the upper hutch.

Exploded View

Vertical Divider
(Inside View)

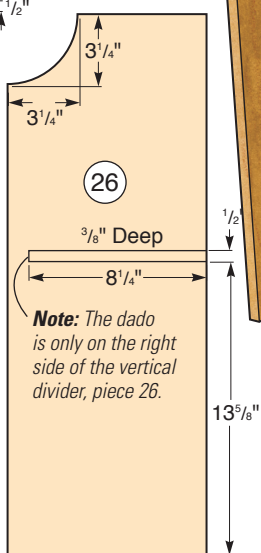

Note: The dado is only on the right side of the vertical divider, piece 26.

MATERIAL LIST

Upper Hutch

	T x W x L
25 Sides (2)	$7\frac{7}{8}'' \times 12'' \times 32''$
26 Vertical Divider (1)	$7\frac{7}{8}'' \times 9\frac{1}{4}'' \times 25\frac{1}{8}''$
27 Short Shelf (1)	$3\frac{1}{4}'' \times 8\frac{1}{2}'' \times 17\frac{1}{8}''$
28 Gallery Shelf (1)	$3\frac{1}{4}'' \times 6\frac{1}{4}'' \times 39''$
29 Top Rail (1)	$3\frac{1}{4}'' \times 6\frac{3}{4}'' \times 39\frac{3}{8}''$
30 Bottom Rail (1)	$3\frac{1}{4}'' \times 3\frac{1}{2}'' \times 39\frac{3}{8}''$
31 Shiplap Back, Random Width (7)	$3\frac{1}{4}'' \times 5''\text{-}6''$ approx. $\times 22\frac{3}{4}''$
32 Back Supports (2)	$3\frac{1}{4}'' \times 2'' \times 21''$